

SEMICONDUCTOR PHYSICS

Introduction:

On the basis of conduction mechanism solids are classified into three categories. Conductors, semiconductors and insulators. In conductors' large no. of free electrons are available which are useful for more electrical conduction mechanism. These materials have very low resistivity and very high conductivity. In insulators no free electrons are available, hence they are not useful for the electrical conduction mechanism. These materials have very high resistivity and almost zero conductivity.

The semiconductors have intermediate properties of conductors and insulators. These materials behave as insulators at low temperatures and as conductors at high temperature. Moreover, these materials have two types of charge carriers, i.e., electrons and holes. The invention of semiconductors opened a new branch of technology "electronics" which led to the development of ICs, microprocessors, computers and supercomputers. These materials play a vital role in almost all advanced electronic devices.

Semiconductors are divided into two types.

1. Intrinsic semiconductors.
2. Extrinsic semiconductors.

INTRINSIC SEMICONDUCTORS

Intrinsic semiconductors are those in which impurities are not present and are therefore called pure semiconductors. In these semiconductors few crystal defects may be present. The Fermi level exists exactly at the mid-way of the energy gap. When a semiconductor is at 0 K, it behaves as an insulator and conduction occurs at high temperatures due to thermal excitation of electrons from the valence band to the conduction band.

Ex:-germanium, silicon etc.

In order to get a clear view of an intrinsic semiconductor, let us consider silicon, which has four valence electrons. In order to gain stability it has to make four covalent bonds with four other silicon atoms as shown in fig.

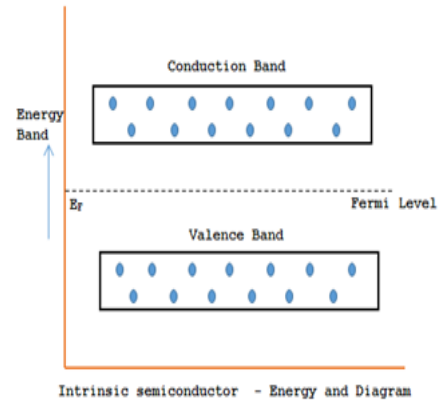
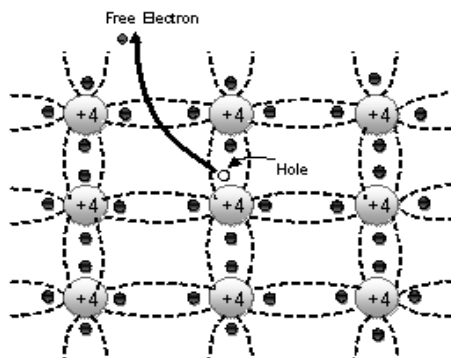

- In electrons which are participating in the covalent bonds are known as valence electrons.
- If some energy is supplied then covalent bonds break electrons will come out and move freely resulting in the formation of vacant sites in the covalent bond these are known as +ve charge carrier named as hole.
- The electrons which come out of the valence band move freely without any constraints and have more energy than the electrons in the covalent bonds or valence band.
- The no. of conduction electrons will be equal to the number of vacant sites or hole in the valence band.
- The no. of holes in the valence band is equal to the no. of electrons in the conduction band. So the Fermi energy level lies midway in the forbidden gap.

EXTRINSIC SEMICONDUCTORS

In intrinsic (or) pure semiconductors the carrier concentration of both electrons and holes at normal temperatures is very low, hence to get appreciable current density through the semiconductors, a large electric field should be applied this problem can be overcome by adding suitable impurities into the intrinsic semiconductors.

The extrinsic semiconductors are those in which impurities can be either III group elements (or) V group elements. Based on the impurities present in the extrinsic semiconductors. They are classified into two categories.

1. N-type semiconductor.
2. P-type semiconductor.

N-Type Semiconductor:

When a pentavalent impurities (or) V group element are doped into a intrinsic semiconductor then four valance electrons of impurities atom make four covalent bond with four intrinsic atoms and fifth electrons is left free as shown in fig.

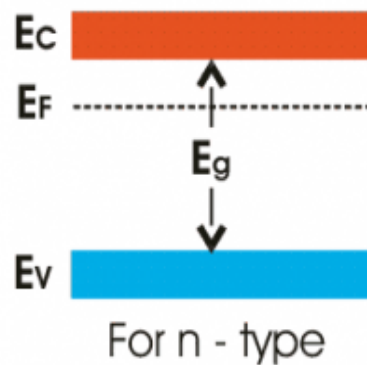
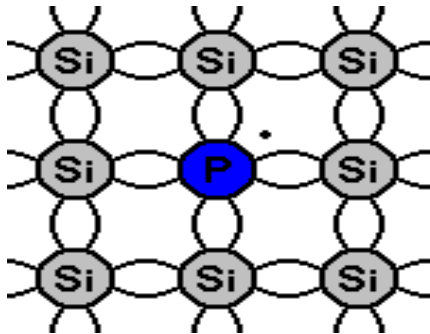

This electrons is free to move anywhere in the crystal and is known as conduction electron which is donated by pentavalent impurity. In this way how many donor impurities are doped into an intrinsic semiconductor that many electrons are donated to the conduction band.

The no. of electrons is more than the number of hole in N-type semiconductor. Hence electrons are majority charge carriers where as holes are the minority charge carriers. So Fermi energy level shift towards conduction band.

P-Type Semiconductor:

When a trivalent impurities (or) III group element are doped into a intrinsic semiconductor then three valance electrons of impurities atom make three covalent bond with three intrinsic atoms and in the fourth bond one position is vacant. It means a trivalent impurity is donating a hole to valence of the intrinsic semiconductor (or) accepting an electron from valence band of the intrinsic semiconductor then trivalent impurity is known as acceptor. Impurity in this way how many acceptor impurities are doped into an intrinsic semiconductor that may holes are donated to a valence band.

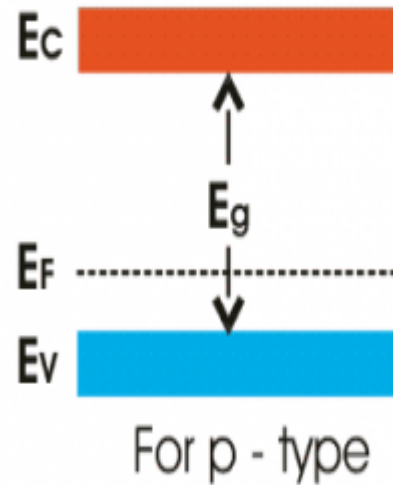
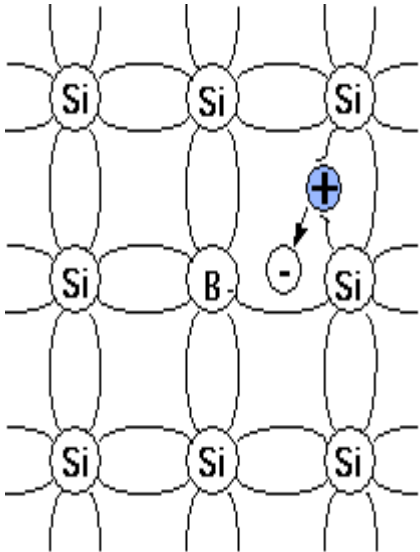

The no. Of holes is more than the no. of electrons in p-type semiconductors. Hence holes are the majority charge carriers and electrons are the minority charge carriers. So the Fermi energy level shifts towards valence band.

DISTINGUISH BETWEEN INTRINSIC AND EXTRINSIC SEMICONDUCTORS

INTRINSIC SEMICONDUCTORS	EXTRINSIC SEMICONDUCTORS
1. It is pure semi-conducting material and no impurity atoms are added to it.	1. It is prepared by doping a small quantity of impurity atoms to the pure semi-conducting material.
2. Examples: crystalline forms of pure silicon and germanium.	2.Examples: silicon "Si" and germanium "Ge" crystals with impurity atoms of As, Sb, P etc. or In B, Al etc.
3. The number of free electrons in the conduction band and the no. of holes in valence band is exactly equal and very	3. The number of free electrons and holes is never equal. There is excess of electrons in n-type semi-conductors and

small indeed.	excess of holes in p-type semi-conductors.
4. Its electrical conductivity is low.	4. Its electrical conductivity is high.
5. Its electrical conductivity is a function of temperature alone.	5. Its electrical conductivity depends upon the temperature as well as on the quantity of impurity atoms doped the structure.

DISTINGUISH BETWEEN N-TYPE AND P-TYPE SEMICONDUCTORS

S.No.	N-type semiconductors	P-type semiconductors
1.	In these the impurity of some pentavalent element like P, As, Sb, Bi, etc. is mixed	In these, the impurity of some trivalent element like b, Al, In, Ga etc. is mixed
2.		
3.	In these the impurity atom donates one electrons, hence these are known as donor type semiconductors	In these, the impurity atom can accept one electron, hence these are known as acceptor type semiconductors.
4.	In these the electrons are majority current carriers and holes are minority current carriers. (i.e. the electron density is more than hole density $n_n \gg n_p$)	In these the holes are majority current carriers and electrons are minority current carriers i.e. $n_p \gg n_n$
5.	In these there is majority of negative particles (electrons) and hence are known as N-type semiconductors 	In these there is majority of positive particles (coppers) and hence are known as P-type semiconductors.
6.	In these the donor energy level is close to the conduction band and far away from valence band.	In these the acceptor energy level is close to the valence band and far away from conduction band.

DENSITY OF STATES

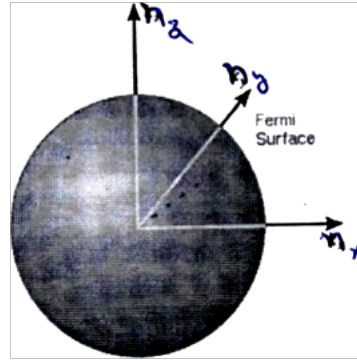

The number of states with energy less than E_f is equal to the number of states that lie within a sphere of radius $|n_f|$ in a region of K-space where n_x , n_y and n_z are positive.

$$\therefore N = 2 \times \frac{1}{8} \times \frac{4}{3} \pi n_f^3$$

$$\therefore N = 2 \times \frac{1}{8} \times \frac{4}{3} \pi n_f^3 = \frac{3N}{\pi} \Rightarrow n_f = \left(\frac{3N}{\pi} \right)^{\frac{1}{3}}$$

So the Fermi energy

$$E_f = \frac{\hbar^2 \pi^2 n_f^2}{2ma^2} = \frac{\hbar^2 \pi^2}{2ma^2} \left(\frac{3N}{\pi} \right)^{\frac{2}{3}}$$

$$E_f = \frac{\hbar^2 \pi^2}{2m a^2} \left(\frac{3N}{\pi} \right)^{\frac{2}{3}} = \frac{\hbar^2 \pi^{\frac{4}{3}} (3N)^{\frac{2}{3}}}{2m (a^3)^{\frac{2}{3}}} = \frac{\hbar^2}{2m} \left(\frac{3N \pi^2}{a^3} \right)^{\frac{2}{3}} = \frac{\hbar^2}{2m} \left(\frac{3N \pi^2}{V} \right)^{\frac{2}{3}}$$

$$\therefore N^{\frac{2}{3}} = \frac{2m}{\hbar^2} \left(\frac{V}{3\pi^2} \right)^{\frac{2}{3}} E_f$$

$$\Rightarrow N = \left(\frac{2m}{\hbar^2} \right)^{\frac{3}{2}} \left(\frac{V}{3\pi^2} \right)^{\frac{3}{2}} E_f^{\frac{3}{2}}$$

Therefore density of states: $D(E) = \frac{dN}{dE} = \frac{3}{2} \left(\frac{2m}{\hbar^2} \right)^{\frac{3}{2}} \left(\frac{V}{3\pi^2} \right)^{\frac{3}{2}} E_f^{\frac{1}{2}}$

$$D(E) = \frac{V}{2\pi^2} \left(\frac{2m}{\hbar^2} \right)^{\frac{3}{2}} E_f^{\frac{1}{2}}$$

Therefore the total number of energy states per unit volume per unit energy range

$$Z(E) = \frac{D(E)}{V} = \frac{1}{2\pi^2} \left(\frac{2m}{\hbar^2} \right)^{\frac{3}{2}} E_f^{\frac{1}{2}} = \frac{1}{2\pi^2} \frac{(2m)^{\frac{3}{2}}}{h^3} 8\pi^3 E_f^{\frac{1}{2}}$$

$$Z(E) = \frac{4\pi}{h^3} (2m)^{\frac{3}{2}} E_f^{\frac{1}{2}}$$

Therefore the number of energy states in the energy interval E and $E + dE$ are

$$Z(E) dE = \frac{4\pi}{h^3} (2m)^2 E_r^{\frac{1}{2}} dE$$

CARRIER CONCENTRATION IN INTRINSIC SEMICONDUCTOR

Let dn be the number of electrons available between energy interval E and $E + dE$ in the conduction band

$$dn = Z(E) F(E) dE \text{ ----- (1)}$$

Where $Z(E) dE$ = density of states in the energy interval E and $E + dE$ and $F(E)$ = probability of an electron occurring in an energy state E .

But we know that $Z(E) dE = \frac{4\pi}{h^3} (2m_e)^2 E_r^{\frac{1}{2}} dE$

Since E starts from the bottom of the conduction band E_c

$$Z(E) dE = \frac{4\pi}{h^3} (2m_e)^2 (E - E_c)^{\frac{1}{2}} dE \text{ ----- (2)}$$

Probability of an electron occupying an energy state E is given by

$$F(E) = \frac{1}{1 + \exp\left(\frac{E - E_r}{KT}\right)}$$

For all temperatures $E - E_r \gg KT$ then $\exp\left(\frac{E - E_r}{KT}\right) \gg 1$

$$\therefore F(E) = \frac{1}{\exp\left(\frac{E - E_r}{KT}\right)} = \exp\left(\frac{E_r - E}{KT}\right) \text{ ----- (3)}$$

From (1), (2) and (3)

$$\begin{aligned} n &= \int dn = \int_{E_c}^{\infty} \frac{4\pi}{h^3} (2m_e)^2 (E - E_c)^{\frac{1}{2}} e^{\frac{E_r - E}{KT}} dE \\ &= \frac{4\pi}{h^3} (2m_e)^2 \int_{E_c}^{\infty} (E - E_c)^{\frac{1}{2}} e^{\frac{E_r - E_c}{KT}} e^{\frac{E_c - E}{KT}} dE \end{aligned}$$

Put $\frac{E_r - E_c}{KT} = x \Rightarrow E_r - E_c = KTx$

$$dE = KT dx \text{ and } (E - E_c)^{\frac{1}{2}} = x^{\frac{1}{2}} (KT)^{\frac{1}{2}}$$

$$n = \frac{4\pi}{h^3} (2m_e)^2 \int_0^{\infty} x^{\frac{1}{2}} (KT)^{\frac{1}{2}} e^{-x} dx$$

$$\therefore n = \frac{4\pi}{h^3} (2m_e KT)^{\frac{3}{2}} e^{\frac{E_r - E_c}{KT}} \int_0^{\infty} x^{\frac{1}{2}} e^{-x} dx$$

Using gamma function it can be shown that

$$\therefore n = \frac{4\pi}{h^3} (2m_e KT)^{\frac{3}{2}} e^{\frac{E_f - E_c}{KT}} \frac{\sqrt{\pi}}{2}$$

$$\text{i.e. } n = 2 \left(\frac{2\pi m_e KT}{h^2} \right)^{\frac{3}{2}} e^{\frac{E_f - E_c}{KT}}$$

CALCULATION OF DENSITY OF HOLES:

Let dP be the number of holes in the energy interval E and $E+dE$ in the valence band

$$dP = Z(E)(1 - F(E)) dE$$

We know that

$$Z(E)dE = \frac{4\pi}{h^3} (2m_h)^{\frac{3}{2}} (E_v - E)^{\frac{1}{2}} dE$$

$$1 - F(E) = 1 - \frac{1}{1 + e^{\frac{E - E_f}{KT}}} = 1 - (1 + e^{\frac{E - E_f}{KT}})^{-1} = 1 - (1 - e^{\frac{E - E_f}{KT}})^{-1} = e^{\frac{E - E_f}{KT}}$$

Therefore the number of holes in the valence band per unit volume is given by

$$p = \int dp = \int_{-\infty}^{E_v} \frac{4\pi}{h^3} (2m_h)^{\frac{3}{2}} (E_v - E)^{\frac{1}{2}} e^{\frac{E - E_f}{KT}} dE$$

$$p = \frac{4\pi}{h^3} (2m_h)^{\frac{3}{2}} \int_{-\infty}^{E_v} (E_v - E)^{\frac{1}{2}} e^{\frac{E - E_f}{KT}} dE$$

$$p = \frac{4\pi}{h^3} (2m_h)^{\frac{3}{2}} \int_{-\infty}^{E_v} (E_v - E)^{\frac{1}{2}} e^{\frac{E}{KT}} e^{\frac{-E_f}{KT}} dE$$

$$p = \frac{4\pi}{h^3} (2m_h)^{\frac{3}{2}} e^{\frac{-E_f}{KT}} \int_{-\infty}^{E_v} (E_v - E)^{\frac{1}{2}} e^{\frac{E}{KT}} dE$$

$$\text{Let } \frac{E_v - E}{KT} = x \Rightarrow E_v - E = xKT$$

$$\text{i.e. } \Rightarrow dE = -KT dx$$

$$\frac{E_v - E}{KT} = x \Rightarrow \frac{E}{KT} = \frac{E_v}{KT} - x$$

$$\therefore p = -\frac{4\pi}{h^3} (2m_h)^{\frac{3}{2}} e^{\frac{-E_f}{KT}} \int_{\infty}^0 x^{\frac{1}{2}} (KT)^{\frac{1}{2}} e^{\frac{E_v}{KT}} e^{-x} dx$$

$$\therefore p = \frac{4\pi}{h^3} (2m_h)^{\frac{3}{2}} e^{\frac{E_v - E_f}{KT}} (KT)^{\frac{3}{2}} \int_0^{\infty} x^{\frac{1}{2}} e^{-x} dx$$

$$\therefore p = \frac{4\pi}{h^3} (2m_h KT)^{\frac{3}{2}} e^{\frac{E_v - E_f}{KT}} \int_0^{\infty} x^{\frac{1}{2}} e^{-x} dx$$

$$p = \frac{4\pi}{h^3} (2m_n K T)^{\frac{3}{2}} e^{\left(\frac{E_v - E_f}{K T}\right)} \frac{\sqrt{\pi}}{2}$$

$$p = 2 \left(\frac{2\pi}{h^3} m_n K T \right)^{\frac{3}{2}} e^{\left(\frac{E_v - E_f}{K T}\right)}$$

Since $n = p = n_i$,

$$n_i^2 = np = 4 \left(\frac{2\pi K T}{h^2} \right)^3 (m_n m_e)^{\frac{3}{2}} e^{\left(\frac{-E_g}{K T}\right)}$$

$$\Rightarrow n_i = 2 \left(\frac{2\pi K T}{h^2} \right)^{\frac{3}{2}} (m_n m_e)^{\frac{3}{4}} e^{\left(\frac{-E_g}{2K T}\right)}$$

Show that in an intrinsic semiconductor Fermi level is at middle of valance band and conduction band:

In an intrinsic semiconductor

$$n = p$$

$$2 \left(\frac{2\pi m_e K T}{h^2} \right)^{\frac{3}{2}} e^{\left(\frac{E_f - E_c}{K T}\right)} = 2 \left(\frac{2\pi}{h^2} m_n K T \right)^{\frac{3}{2}} e^{\left(\frac{E_v - E_f}{K T}\right)}$$

$$m_e^{\frac{3}{2}} \left(\frac{2\pi K T}{h^2} \right)^{\frac{3}{2}} e^{\left(\frac{E_f - E_c}{K T}\right)} = m_n^{\frac{3}{2}} \left(\frac{2\pi}{h^2} m_n K T \right)^{\frac{3}{2}} e^{\left(\frac{E_v - E_f}{K T}\right)}$$

$$\left(\frac{m_n}{m_e} \right)^{\frac{3}{2}} = \exp\left(\frac{E_f - E_c - E_v + E_f}{K T}\right) = \exp\left(\frac{2E_f - E_v - E_c}{K T}\right)$$

Taking logarithm on both sides we get

$$\frac{3}{2} \log \frac{m_n}{m_e} = \frac{2E_f - E_v - E_c}{K T}$$

$$\Rightarrow 2E_f = E_v + E_c + \frac{3}{2} K T \log \frac{m_n}{m_e}$$

$$\text{i.e. } E_f = \frac{E_v + E_c}{2} + \frac{3}{4} K T \log \frac{m_n}{m_e}$$

But $m_n = m_e$

$$\Rightarrow E_f = \frac{E_v + E_c}{2}$$

i.e. Fermi level is located half way between valance band and conduction band and the position is independent of temperature.

CONDUCTIVITY IN INTRINSIC SEMICONDUCTORS:

Since $n = p = n_i$,

$$n_i^2 = np = 4 \left(\frac{2\pi K T}{h^2} \right)^3 (m_n m_p)^2 e^{\frac{-E_g}{K T}}$$

$$\Rightarrow n_i = 2 \left(\frac{2\pi K T}{h^2} \right)^{\frac{3}{2}} (m_n m_p)^{\frac{3}{4}} e^{\frac{-E_g}{2 K T}}$$

Where E_g is the energy gap and it is equal to $E_g = E_c - E_v$

Therefore electrical conductivity $\sigma = ne\mu_e + pe\mu_h = n_i e (\mu_e + \mu_h)$

$\sigma = A e^{\frac{-E_g}{2 K T}}$ And as T increases σ increases.

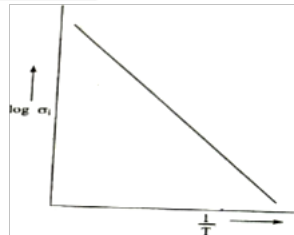

CARRIER CONCENTRATION IN N-TYPE SEMICONDUCTORS.

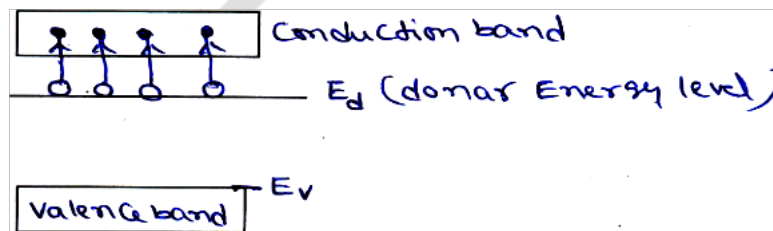

The energy level diagram of an N-type semiconductor is shown in the fig. At very low temperatures all the donor levels are filled with electrons. With increase of temperature more and more atoms get excited and the density of electrons in the conduction band increases.

Density of electrons in the conduction band

$n_e = 2 \left(\frac{2\pi m_e K T}{h^2} \right)^{\frac{3}{2}} e^{\frac{E_c - E_f}{K T}}$ ----- (1) but the number of vacancies per unit

volume in the donor level is given by $N_d (1 - F(E)) = N_d \left[1 - \frac{1}{e^{\frac{E_d - E_f}{K T}} + 1} \right]$

$= N_d \left[1 - \left(1 - e^{\frac{E_d - E_f}{K T}} \right) \right] = N_d e^{\frac{E_d - E_f}{K T}}$ ----- (2)

But the number of electrons in the conduction band is equal to the number of vacancies in the donor level.

$$2 \left(\frac{2\pi m_e K T}{h^2} \right)^{\frac{3}{2}} e^{\frac{E_c - E_f}{K T}} = N_d e^{\frac{E_d - E_f}{K T}}$$

Taking log on both sides

$$\log 2 \left(\frac{2\pi m K T}{h^2} \right)^{\frac{3}{2}} + \frac{E_r - E_c}{K T} = \log N_d + \frac{E_d - E_r}{K T}$$

$$\frac{E_r - E_c - E_d + E_r}{K T} = \log N_d - \log 2 \left(\frac{2\pi m K T}{h^2} \right)^{\frac{3}{2}}$$

$$2E_r - (E_c + E_d) = K T \left[\log \frac{N_d}{2 \left(\frac{2\pi m K T}{h^2} \right)^{\frac{3}{2}}} \right]$$

$$E_r = \frac{(E_c + E_d)}{2} + \frac{K T}{2} \left[\log \frac{N_d}{2 \left(\frac{2\pi m K T}{h^2} \right)^{\frac{3}{2}}} \right] \text{----- (3)}$$

$$\text{At OK } E_r = \frac{(E_c + E_d)}{2}$$

DENSITY OF ELECTRONS IN CONDUCTION BAND: We know that $n = 2 \left(\frac{2\pi m_e K T}{h^2} \right)^{\frac{3}{2}} e^{\left(\frac{E_r - E_c}{K T} \right)}$

On substituting the value of E_r from equ. (3) In the above equation we get

$$n = 2 \left(\frac{2\pi m_e K T}{h^2} \right)^{\frac{3}{2}} e^{\left(\frac{\frac{(E_c + E_d)}{2} + \frac{K T}{2} \left[\log \frac{N_d}{2 \left(\frac{2\pi m K T}{h^2} \right)^{\frac{3}{2}}} \right] - E_c}{K T} \right)}$$

$$n = 2 \left(\frac{2\pi m_e K T}{h^2} \right)^{\frac{3}{2}} \exp \left(\frac{(E_c + E_d)}{2 K T} + \frac{1}{2} \log \frac{N_d}{2 \left(\frac{2\pi m K T}{h^2} \right)^{\frac{3}{2}}} - \frac{E_c}{2 K T} \right)$$

$$n = 2 \left(\frac{2\pi m_e K T}{h^2} \right)^{\frac{3}{2}} \exp \left(\frac{(E_d - E_c)}{2 K T} + \frac{1}{2} \log \frac{N_d}{2 \left(\frac{2\pi m K T}{h^2} \right)^{\frac{3}{2}}} \right)$$

$$n = 2 \left(\frac{2\pi m_e K T}{h^2} \right)^{\frac{3}{2}} \exp \left(\frac{(E_d - E_c)}{2 K T} + \log \frac{N_d^{\frac{1}{2}}}{2^{\frac{1}{2}} \left(\frac{2\pi m K T}{h^2} \right)^{\frac{3}{4}}} \right)$$

$$n = 2 \left(\frac{2\pi m_e K T}{h^2} \right)^{\frac{3}{2}} \frac{N_d^{\frac{1}{2}}}{2^{\frac{1}{2}} \left(\frac{2\pi m K T}{h^2} \right)^{\frac{3}{4}}} \exp \left(\frac{(E_d - E_c)}{2 K T} \right)$$

$$n = (2 N_d)^{\frac{1}{2}} \left(\frac{2\pi m_e K T}{h^2} \right)^{\frac{3}{4}} \exp \left(\frac{(E_d - E_c)}{2 K T} \right)$$

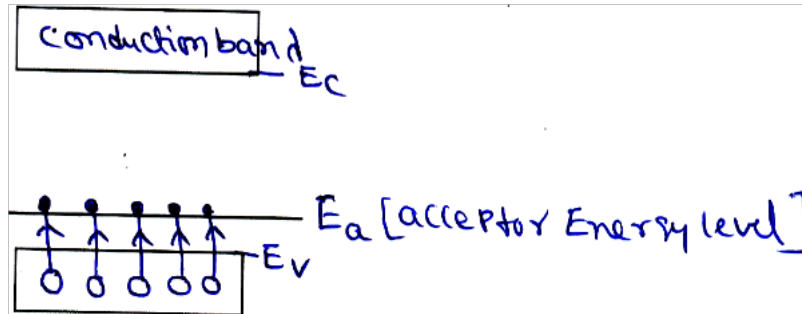
CARRIER CONCENTRATION IN P-TYPE SEMICONDUCTORS:

The energy level diagram of a p-type semiconductor is shown in the fig.

N_a is the acceptor concentration i.e. the number of acceptor atoms per unit volume of the material and E_a is the acceptor energy level. At very low temperatures all the acceptor levels are empty. With increase of temperature the electrons move from valance band and occupy the vacant sites in the acceptor energy level, thereby leaving holes in the valance band.

The density of holes in the valance band is given by

$$p = 2 \left(\frac{2\pi}{h^2} m_h K T \right)^{\frac{3}{2}} e^{-\frac{E_v - E_f}{K T}} \text{----- (1)}$$

Since E_f lies below acceptor level then density of ionized acceptor is given by

$$N_a F(E) = N_a e^{-\frac{E_f - E_a}{K T}}$$

Since the density of holes in the valance band is equal to the density of ionized acceptor

$$\text{i.e. } 2 \left(\frac{2\pi}{h^2} m_h K T \right)^{\frac{3}{2}} e^{-\frac{E_v - E_f}{K T}} = N_a e^{-\frac{E_f - E_a}{K T}}$$

$$\exp\left(\frac{E_v - E_f - E_f + E_a}{K T}\right) = \frac{N_a}{2 \left(\frac{2\pi}{h^2} m_h K T \right)^{\frac{3}{2}}}$$

Taking logarithm on both sides we get

$$\frac{E_v - E_f - E_f + E_a}{K T} = \log \frac{N_a}{2 \left(\frac{2\pi}{h^2} m_h K T \right)^{\frac{3}{2}}}$$

$$\text{i.e. } E_f = \frac{E_v + E_a}{2} - \frac{K T}{2} \log \frac{N_a}{2 \left(\frac{2\pi}{h^2} m_h K T \right)^{\frac{3}{2}}} \text{----- (2)}$$

$$\text{At OK } E_f = \frac{E_v + E_a}{2}$$

i.e. at OK Fermi level will be exactly at the middle of acceptor level
The density of holes in the valance band is given by

$$p = 2 \left(\frac{2\pi}{h^2} m_h K T \right)^{\frac{3}{2}} e^{\left(\frac{E_v - E_f}{K T} \right)}$$

On substituting the value of E_f from equation (2) we get

$$p = 2 \left(\frac{2\pi}{h^2} m_h K T \right)^{\frac{3}{2}} \exp \left(\frac{E_v}{K T} - \frac{1}{K T} \left(\frac{E_v + E_a}{2} - \frac{K T}{2} \log \frac{N_a}{2 \left(\frac{2\pi}{h^2} m_h K T \right)^{\frac{3}{2}}} \right) \right)$$

$$p = 2 \left(\frac{2\pi}{h^2} m_h K T \right)^{\frac{3}{2}} \exp \left(\frac{2E_v}{2KT} - \frac{E_v + E_a}{2KT} \right) \frac{N_a^{\frac{1}{2}}}{\left[2 \left(\frac{2\pi}{h^2} m_h K T \right)^{\frac{3}{2}} \right]^{\frac{1}{2}}}$$

$$p = 2 \left(\frac{2\pi}{h^2} m_h K T \right)^{\frac{3}{2}} \frac{N_a^{\frac{1}{2}}}{\left[2 \left(\frac{2\pi}{h^2} m_h K T \right)^{\frac{3}{2}} \right]^{\frac{1}{2}}} \exp \left(\frac{E_v - E_a}{2KT} \right)$$

$$p = (2N_a)^{\frac{1}{2}} \left(\frac{2\pi}{h^2} m_h K T \right)^{\frac{3}{4}} \exp \left(\frac{E_v - E_a}{2KT} \right)$$

HALL EFFECT:

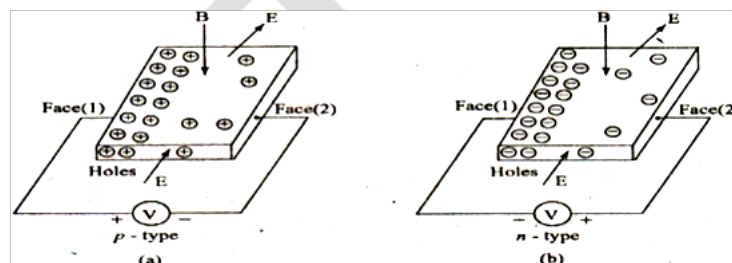

When a piece of conductor (metal or semiconductor) carrying a current is placed in a transverse magnetic field, an electric field is produced inside the conductor in a direction normal to both the current and magnetic field. This phenomenon is called Hall Effect and the generated voltage is known as Hall-voltage.

Let B be the applied magnetic field at right angle to the direction of the current flow. If the material is N-type and v is the velocity of the electrons then the electrons will experience a force of Bev due to magnetic field at right angle to both the direction and B . This causes the electron current to be deflected causing a negative charge to accumulate on one face of the slab, a PD is therefore established across the faces (1) and (2). This field giving rise to a force eE_H on electrons in the opposite directions.

$$\text{At equilibrium } eE_H = Bev$$

$$E_H = Bv$$

$$\text{But } J = nev \Rightarrow v = \frac{J}{ne}$$

$$E_H = \frac{BJ}{ne} = R_H BJ \text{ where } R_H = \frac{1}{ne} = \frac{E_H}{BJ}$$

Since all the three quantities E_H , B and J are measurable then Hall coefficient R_H and carrier density can be calculated.

$$\text{For N-type material } R_H = -\frac{1}{ne}$$

$$\text{For p-type material } R_H = \frac{1}{ne}$$

Based on this we can identify the type of charge.

Determination of hall coefficient R_H

If b is the width of the sample across the Hall voltage V_H is measured then

$$E_H = \frac{V_H}{b}$$

$$\text{Hence } R_H = \frac{E_H}{BJ} = \frac{V_H}{BJb}$$

$$V_H = R_H BJb$$

If t is the thickness of the sample then its cross section is bt and current density

$$J = \frac{I}{bt}$$

$$\text{Hence } V_H = \frac{R_H BIb}{t}$$

$$\text{i.e. } \boxed{R_H = \frac{V_H t}{IB}}$$

V_H Will be opposite for N-and P-type semiconductors.

Applications of Hall Effect

1. The sign of charge carriers can be determined.
2. The carrier density can be estimated.
3. The mobility of charge carriers can be measured directly.
4. It can be used to determine whether the given material is a metal, an insulator or a semiconductor.
5. The magnetic field can be measured by knowing the values of Hall voltage and Hall coefficient.

Drift current or conduction current in semiconductors:

In semiconductors the electrical conductivity is due to the concentration of electrons and holes. When an electric field is applied across the semiconductor the

applied electric field causes the free electrons to drift towards positive direction and holes to drift towards negative direction of electric field.

The total current due to holes and electrons in the presence of electric field is called drift current or conduction current in semi conductors.

$$\text{Total drift current } I_{\text{drift}} = I_{\text{electrons}} + I_{\text{holes}}$$

$$\text{i.e. } I_{\text{drift}} = ne\mu_e EA + p\mu_h EA = eEA(n\mu_e + p\mu_h)$$

in case of intrinsic semiconductors $n = p = n_i$

$$I_{\text{drift}} = n_i eEA(\mu_e + \mu_h)$$

$$J_{\text{drift}} = n_i eE(\mu_e + \mu_h)$$

Therefore electrical conductivity of intrinsic semiconductor due to drifting action of electrons and holes is given by

$$\sigma_{\text{drift}} = n_i e(\mu_e + \mu_h)$$

Diffusion current in semiconductors:

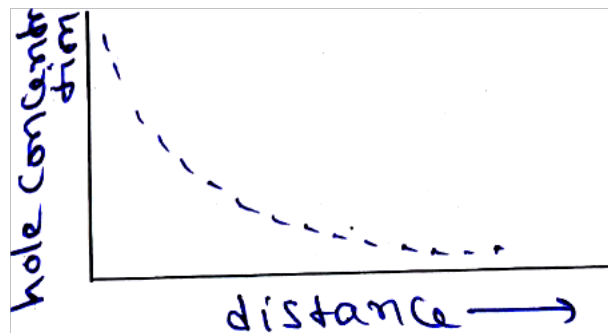

The figure shows the variation of holes density with distance in semiconductors. There exists a concentration gradient $\frac{dp}{dx}$

Thus the motion of charge carriers from the region of higher concentration leads to a current called diffusion current.

$$\text{Hole current density } J_p \propto \frac{dp}{dx} \propto e$$

$$\text{i.e. } J_p = -eD_p \frac{dp}{dx}$$

$$\text{Electron current density } J_n \propto \frac{dn}{dx}$$

$$J_n \propto e$$

$$J_n = eD_n \frac{dn}{dx}$$

The total diffusion current density $J_{\text{diffusion}} = J_p + J_n$

$$\text{i.e. } J_{\text{diffusion}} = -e(D_p \frac{dp}{dx} + D_n \frac{dn}{dx})$$

Therefore current density in semiconductors $J_{\text{diffusion}} + J_{\text{drift}}$

$$\text{ie } J = e(n_e E (\mu_e + \mu_h) - D_p \frac{dp}{dx} + D_n \frac{dn}{dx})$$

EINSTEIN RELATION:

Semiconductor devices in general operate under non-equilibrium conditions. For example when a bar of n-type germanium acting as a photo detecting device, is illuminated with a light of sufficient energy, excess charge carriers are produced in the exposed region of the material. Hence the semiconductor is not in thermal equilibrium. This leads to a diffusion current creating an internal electric field and drift current balances the diffusion component.

Let Δn be the number of charge carriers increased in a particular region then

$$\Delta n e E \mu_e = e D_n \frac{\partial \Delta n}{\partial x} \text{ ---- (1)}$$

The force F on excess carriers restoring equilibrium is given by

$$F = \Delta n e E = \frac{e D_n}{\mu_e} \frac{\partial \Delta n}{\partial x} \text{ ----- (2)}$$

According to kinetic theory of gasses increased pressure = $\Delta n k T$

$$\text{i.e. Force} = k T \frac{\partial \Delta n}{\partial x} \text{ ----- (3)}$$

from (2) and (3) we get

$$k T \frac{\partial \Delta n}{\partial x} = \frac{e D_n}{\mu_e} \frac{\partial \Delta n}{\partial x}$$

$$\frac{e D_n}{\mu_e} = k T \Rightarrow D_n = \frac{\mu_e k T}{e}$$

$$\text{Similarly } D_p = \frac{\mu_h k T}{e}$$

These are called Einstein Relations.

DISTINGUISH BETWEEN DIRECT AND INDIRECT BAND GAP SEMI CONDUCTORS

DIRECT BAND GAP SEMICONDUCTOR	INDIRECT BAND GAP SEMICONDUCTOR
1. These are also known as compound semiconductors	1. These are also known as elemental semiconductors

2.The maximum of the valance band occurs at the same value of k as the minimum of the conduction band	2. The maximum of valance band does not always occur at the same value of k as the minimum of conduction band.
3. The life time (i.e, recombination time) of charge carries are very less.	3. The life time (i.e., recombination time) of charge carries are very high.
4. These are used to fabricate LEDs and Laser diode.	4. These are used to amplify the signals as in the case of diodes and transistors.
5.Ex: InP, GaAs etc.	5. Ex: Si, Ge.

QUESTION BANK

1.
 - a. Derive an expression for the number of electrons per unit volume in the conduction band of an N-type semiconductor.
 - b Explain the effect of temperature and dopant on Fermi level in N-type semiconductor
2.
 - a Explain Hall effect. Derive the expression for Hall coefficient of N-type semiconductor.
 - b Explain the applications of hall effect.
3.
 - a what is intrinsic semiconductor? Derive an expression for electron concentration in an intrinsic semiconductor.
 - b Distinguish between direct and indirect band gap semiconductors.
4.
 - a What is intrinsic semiconductor? Derive an expression for hole concentration in an intrinsic semiconductor
 - b Explain drift and diffusion currents.
5.
 - a Derive an expression for the number of holes per unit volume in the valence band of P-type semiconductors
 - b Derive Einstein relation.

SEMICONDUCTORS

The material which allows electricity partially through it is called semiconductor.

Conductivity of semiconductor lies between conductors and insulators.

Silicon and Germanium are the examples for semiconductors. The energy gap for Si is 1.1eV and for Ge is 0.7eV.

INTRINSIC or PURE SEMICONDUCTOR:

Let us consider 'Si' with atomic no. 14 and valence is 4. All the silicon atoms form covalent bonds with the neighboring Si atom and no electron is free for conduction at temperature 0 k. Hence pure silicon acts as *insulator* at absolute 0 k, as the temperature increases above 0 k, these covalent bonds break and some electrons are released. These electrons move in the crystal freely and responsible for conductivity. So they are called free electrons.

Each electron leaves behind an empty space called a hole which also acts as current carrier. These electrons and holes move in opposite directions under the effect of external field and constitute current.

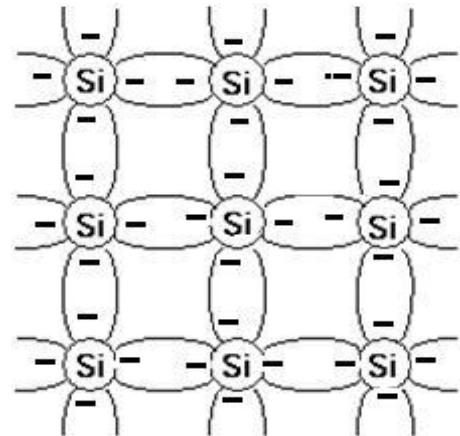

ELECTRON CONCENTRATION IN THE CONDUCTION BAND OF INTRINSIC SEMICONDUCTOR:

The no. of electrons per unit volume having energy in a range E and E+dE in the conduction band of an intrinsic semiconductor is,

$$dn = Z(E)dE F(E) \text{ -----(1)}$$

where F(E) represents the Fermi distribution function gives the probability of occupation of electron with energy E.

$$F(E) = \frac{1}{1 + \exp\left(\frac{E - E_F}{K_B T}\right)}$$

Z(E) is the density of states i.e. no. of available states per unit volume of semiconductor.

$$Z(E) = \frac{4\Pi}{h^3} (2m)^{3/2} E^{1/2}$$

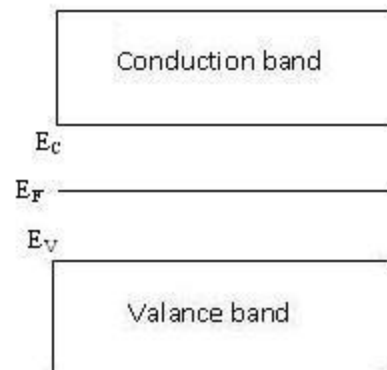

$$dn = \frac{4\Pi}{h^3} (2m)^{3/2} E^{1/2} \cdot \frac{1}{1 + \exp\left(\frac{E - E_F}{K_B T}\right)} dE$$

For conduction band,

$$dn = \frac{4\Pi}{h^3} (2m_e^*)^{3/2} (E - E_c)^{1/2} \cdot \frac{1}{1 + \exp\left(\frac{E - E_F}{K_B T}\right)} dE \text{ ----- (2)}$$

Where m_e^* is effective mass of electron in the conduction band.

in the above equation, for conduction band, $\exp\left(\frac{E - E_F}{K_B T}\right) \gg 1$ so 1 can be neglected in the denominator of the equ.(2).

$$dn = \frac{4\Pi}{h^3} (2m_e^*)^{3/2} (E - E_c)^{1/2} \exp\left(\frac{-(E - E_F)}{K_B T}\right) \text{ ----- (3)}$$

To get the total no. of electrons per unit vol. in the conduction band is we have to integrate the above equ. Between the bottom of the conduction to top of the conduction band.

$$\therefore n = \frac{4\Pi}{h^3} (2m_e^*)^{3/2} \int_{E_c}^{\infty} (E - E_c)^{1/2} \exp\left(\frac{-(E - E_F)}{K_B T}\right) dE$$

$$dn = \frac{4\Pi}{h^3} (2m_e^*)^{3/2} \int_{E_c}^{\infty} (E - E_c)^{1/2} \exp\left(\frac{-(E - E_F + E_c - E_c)}{K_B T}\right) dE$$

$$n = \frac{4\Pi}{h^3} (2m_e^*)^{3/2} \exp\left(\frac{(E_F - E_c)}{K_B T}\right) \int_{E_c}^{\infty} (E - E_c)^{1/2} \exp\left(\frac{-(E - E_c)}{K_B T}\right) dE$$

put $x = \left(\frac{E - E_c}{K_B T}\right)$, so that $dE = K_B T dx$

Lower Limit: when $E = E_c$, $x = 0$ and

Upper Limit: when $E = \infty$, $x = \infty$

$$\therefore n = \frac{4\Pi}{h^3} (2m_e^*)^{3/2} \exp\left(\frac{(E_F - E_c)}{K_B T}\right) \int_0^{\infty} e^{-x} (x K_B T)^{1/2} K_B T dx$$

$$n = \frac{4\Pi}{h^3} (2m_e^* K_B T)^{3/2} \exp\left(\frac{(E_F - E_c)}{K_B T}\right) \int_0^{\infty} e^{-x} (x)^{1/2} dx$$

$$n = 4\pi \left[\frac{2m_e^* k_B T}{h^2} \right]^{3/2} \exp\left(\frac{(E_F - E_c)}{K_B T}\right) \frac{\sqrt{\pi}}{2}$$

$$n = 2 \left[\frac{2\pi m_e^* k_B T}{h^2} \right]^{3/2} \exp\left(-\frac{(E_c - E_F)}{K_B T}\right)$$

$$n = N_c \exp\left(-\frac{(E_c - E_F)}{K_B T}\right)$$

$$\text{Where } N_c = 2 \left[\frac{2\pi m_e^* k_B T}{h^2} \right]^{3/2}$$

HOLE CONCENTRATION IN THE VALENCE BAND OF INTRINSIC SEMI CONDUCTOR:

The no. of holes per unit volume having energy in a range E and E+dE in the valence band of an intrinsic semiconductor is,

$$dp = Z(E)dE [1-F(E)] \text{ -----(1)}$$

where [1-F(E)] represents the probability of absence of electron in the particular energy level with energy E.

$$[1-F(E)] = 1 - \frac{1}{1 + \exp\left(\frac{E - E_F}{K_B T}\right)} = \frac{\exp\left(\frac{E - E_F}{K_B T}\right)}{1 + \exp\left(\frac{E - E_F}{K_B T}\right)}$$

For the valence band $1 \gg \exp\left(\frac{E - E_F}{K_B T}\right)$.

So exponential term can be neglected in the denominator of the above equation.

$$\therefore [1-F(E)] = \exp\left(\frac{E - E_F}{K_B T}\right)$$

$$dP = \frac{4\pi}{h^3} (2m)^{3/2} E^{1/2} \exp\left(\frac{E - E_F}{K_B T}\right) dE$$

For valence band,

$$dp = \frac{4\pi}{h^3} (2m^*_h)^{3/2} (E_v - E)^{1/2} \exp\left(\frac{E - E_F}{K_B T}\right) dE$$

To get the total no. of holes in the V.B. we have to integrate the above equation between the limits bottom of the V.B. to top of the V.B.

$$p = \frac{4\Pi}{h^3} (2m_h^*)^{3/2} \int_{-\infty}^{E_v} (E_v - E)^{1/2} \exp\left(\frac{E - E_F}{K_B T}\right) dE$$

$$p = \frac{4\Pi}{h^3} (2m_h^*)^{3/2} \int_{-\infty}^{E_v} (E_v - E)^{1/2} \exp\left(\frac{E - E_F + E_v - E_v}{K_B T}\right) dE$$

$$p = \frac{4\Pi}{h^3} (2m_h^*)^{3/2} \exp\left(\frac{E_v - E_F}{K_B T}\right) \int_{-\infty}^{E_v} (E_v - E)^{1/2} \exp\left(-\frac{E_v - E}{K_B T}\right) dE$$

$$\text{put } \left(\frac{E_v - E}{K_B T}\right) = x; \quad dE = -dx K_B T$$

Lower Limit: when $E = -\infty$, $x = \infty$.

Upper Limit: when $E = E_v$, $x = 0$.

$$\therefore p = \frac{4\Pi}{h^3} (2m_h^*)^{3/2} \exp\left(\frac{E_v - E_F}{K_B T}\right) \int_{\infty}^0 e^{-x} (x K_B T)^{1/2} (-K_B T dx)$$

$$p = \frac{4\Pi}{h^3} (m_h^* K_B T)^{3/2} \exp\left(\frac{E_v - E_F}{K_B T}\right) \int_0^{\infty} e^{-x} x^{1/2} dx$$

$$p = \frac{4\Pi}{h^3} (2m_h^* K_B T)^{3/2} \exp\left(\frac{E_v - E_F}{K_B T}\right) \frac{\sqrt{\Pi}}{2}$$

$$p = 2 \left(\frac{2m_h^* \pi k_B T}{h^2}\right)^{\frac{3}{2}} \exp\left(\frac{E_v - E_F}{K_B T}\right) \text{ or}$$

$$p = N_v \exp\left(-\frac{E_F - E_v}{K_B T}\right) \text{----- (2)}$$

Where $N_v = 2 \left(\frac{2m_h^* \pi k_B T}{h^2}\right)^{\frac{3}{2}}$ Equ. (2) gives the no. of holes in the V.B of the intrinsic semi conductor.

LOCATION OF FERMI LEVEL IN INTRINSIC SEMICONDUCTOR:

In intrinsic semiconductor no. of electrons in the C.B and no. of holes in the V.B are equal.

$$\therefore n = p$$

$$N_c \exp\left(-\frac{(E_c - E_F)}{K_B T}\right) = N_v \exp\left(-\frac{(E_F - E_v)}{K_B T}\right)$$

$$\exp\left(\frac{-E_c + E_F + E_F - E_v}{K_B T}\right) = \frac{N_v}{N_c}$$

$$\frac{2E_F}{K_B T} - \frac{(E_c + E_v)}{K_B T} = \ln \frac{N_v}{N_c}$$

$$E_F = \frac{(E_c + E_v)}{2} + \frac{K_B T}{2} \ln \frac{N_v}{N_c} \text{ ----- (1)}$$

At $T = 0$ K,

$$E_F = \frac{(E_c + E_v)}{2} \text{ ----- (2)}$$

Fermi energy level lies exactly in the middle of the forbidden gap at absolute zero K.

INTRINSIC CARRIER CONCENTRATION (n_i) [law of mass action]:

In the intrinsic semiconductor, $n = p = n_i$

Where n_i is known as intrinsic carrier concentration.

$$\therefore np = n_i^2$$

$$n_i^2 = 2 \left[\frac{2 m_e^* \pi k_B T}{h^2} \right]^{3/2} \exp\left(-\frac{(E_c - E_F)}{K_B T}\right) 2 \left[\frac{2 m_h^* \pi k_B T}{h^2} \right] \exp\left(-\frac{(E_F - E_v)}{K_B T}\right)$$

$$n_i^2 = 4 \left[\frac{2 \pi k_B T}{h^2} \right]^3 (m_e^* m_h^*)^{3/2} \exp\left(\frac{-E_c + E_F - E_F + E_v}{K_B T}\right)$$

$$n_i^2 = 4 \left[\frac{2 \pi k_B T}{h^2} \right]^3 (m_e^* m_h^*)^{3/2} \exp\left(\frac{-(E_c - E_v)}{K_B T}\right)$$

$$n_i = 2 \left[\frac{2 \pi k_B T}{h^2} \right]^{3/2} (m_e^* m_h^*)^{3/4} \exp\left(\frac{-E_g}{2K_B T}\right) \text{ (since } E_c - E_v = E_g)$$

This equ. Shows that for a given semiconductor the product of holes and electron concentration at a given temp. is equal to square of the intrinsic semiconductor carrier concentration. This is called law of mass action and holds both for intrinsic and extrinsic semiconductors.

CONDUCTIVITY OF INTRINSIC SEMICONDUCTORS:

When the electric field is applied to the semiconductor, charge carriers acquire velocity.

$$v_d \propto E$$

$$v_d = \mu E \text{ ----- (1)}$$

where μ is called mobility of charge carriers.

$$\text{Current density } J = ne v_d$$

$$J = ne\mu E \text{ ----- (2)}$$

This is in the form of $J = \sigma E$

Where $\sigma = ne\mu$ ----- (3) is conductivity

For electrons $\sigma_n = ne\mu_e$

For holes $\sigma_p = pe\mu_h$

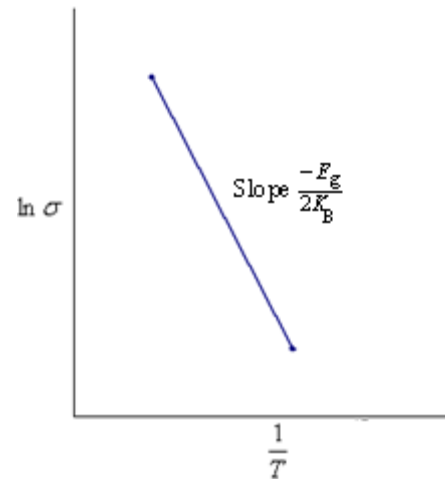

Where μ_e, μ_h are mobilities of electrons and holes respectively.

$$\therefore \sigma = ne\mu_e + pe\mu_h$$

$$= (n\mu_e + p\mu_h)e$$

$$= n_i(\mu_e + \mu_h)e \text{ ----- (4) where } n_i \text{ is called intrinsic carrier concentration.}$$

$$\sigma = 2 \left[\frac{2 \Pi k_B T}{h^2} \right]^{3/2} (m_e^* m_h^*)^{3/4} \exp\left(\frac{-E_g}{2K_B T}\right) (\mu_e + \mu_h)e$$

$$\sigma = \sigma_o \exp\left(\frac{-E_g}{2K_B T}\right) \text{ where } \sigma_o = 2 \left[\frac{2 \Pi k_B T}{h^2} \right]^{3/2} (m_e^* m_h^*)^{3/4} (\mu_e + \mu_h)e$$

$$\ln \sigma = \ln \sigma_o - \frac{E_g}{2K_B T} \text{ -----(4)}$$

The above equ. gives the expression for conductivity of intrinsic semiconductor.

EXTRINSIC SEMICONDUCTORS:

To increase the conductivity of pure semiconductors some impurities are added. This process is called doping. When impurities are added to semiconductor the available energy levels are altered. One or more energy levels are appeared in the band structure. Doping may create energy levels with in the forbidden band.

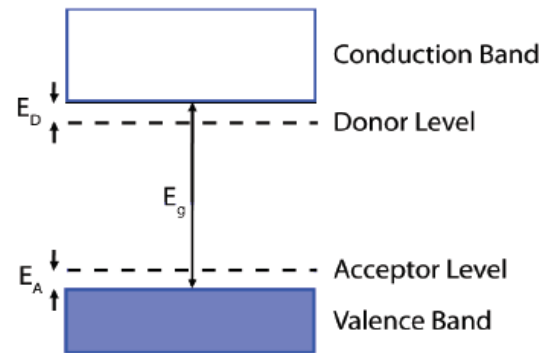

N-type semiconductor:-

When pentavalent impurities such as phosphorous, Arsenic or Antimony is introduced into Si, or Ge, four of its valence electrons form 4 covalent bonds with other 4 neighboring Si or Ge atoms while the fifth valence electron loosely bound to its nucleus. A small amount of energy is required to detach fifth electron from its nucleus and make it free to conduct.

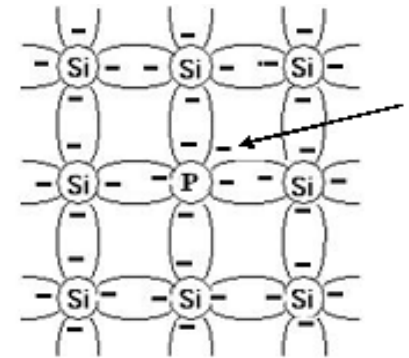

So pentavalent impurities are known as donor impurities.

The energy level corresponding to the fifth valence electron lies in the band gap just below the C.B. edge as shown in figure.

This level is called donor level.

ELECTRON CONCENTRATION IN N-TYPE SEMICONDUCTOR:

The energy level diagram for n-type semiconductor is shown in fig. At 0k all donor levels are unionized state that is all donor levels are occupied with electrons. As temperature increases slightly some of the donors ionized and contribute electrons to the conduction band. Also some of the valence electrons may jump to the conduction band leaving hole in valence band. The no. of holes produced quite small in this process. Therefore Fermi level must lie near the middle of the donor level and bottom of the conduction band.

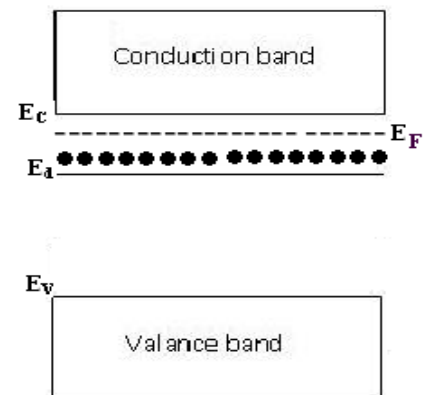

Let there be N_d donors per unit volume occupying donor levels with energy E_d . The electron concentration in the conduction band is given by

$$n = N_c \exp\left(-\frac{(E_c - E_F)}{K_B T}\right) \text{----- (1)}$$

The electron concentration must be equal to the sum of concentration of ionized donors in donor levels and concentration of thermally generated holes in valence band. i.e.

$$n = N_d^+ + p \text{ ----- (2)}$$

If donors concentration is high, the holes generated can be neglected.

$$\therefore n \approx N_d^+ \text{ ----- (3)}$$

The concentration of ionized donors can be written as

$$N_d^+ = N_d[1-F(E_d)]$$

$$= N_d \left[1 - \frac{1}{1 + \exp\left(\frac{E_d - E_F}{K_B T}\right)} \right]$$

$$= N_d \left[\frac{\exp\left(\frac{E_d - E_F}{K_B T}\right)}{1 + \exp\left(\frac{E_d - E_F}{K_B T}\right)} \right]$$

$$= N_d \exp\left[-\left(\frac{E_F - E_d}{K_B T}\right)\right] \text{ ----- (4)}$$

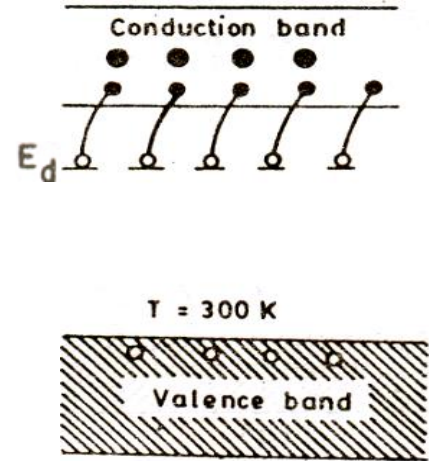

In n-type semiconductor E_F lies above the E_d , $1 \gg \exp\left(\frac{E_d - E_F}{K_B T}\right)$. So exponential term can be neglected in the denominator of the above equation.

From equations (3) and (4), we get

$$N_c \exp\left[-\left(\frac{E_c - E_F}{K_B T}\right)\right] = N_d \exp\left[-\left(\frac{E_F - E_d}{K_B T}\right)\right]$$

$$\exp\left(\frac{-E_c + E_F + E_F - E_d}{K_B T}\right) = \frac{N_d}{N_c}$$

$$\left(\frac{2E_F}{K_B T} - \frac{(E_c + E_d)}{K_B T}\right) = \ln \frac{N_d}{N_c}$$

$$E_F = \frac{E_c + E_d}{2} + \frac{K_B T}{2} \ln \frac{N_d}{N_c} \text{ ----- (5)}$$

Substitute the value of E_F in equ.(1)

$$n = N_c \exp \left(\frac{-E_c}{K_B T} + \frac{E_c + E_d}{2K_B T} + \frac{\ln \frac{N_d}{N_c}}{2} \right)$$

$$n = N_c \exp \left(\frac{-2E_c + E_c + E_d}{2K_B T} + \frac{\ln \frac{N_d}{N_c}}{2} \right)$$

$$n = N_c \exp \left(\frac{E_d - E_c}{2K_B T} + \ln \left(\frac{N_d}{N_c} \right)^{\frac{1}{2}} \right)$$

$$n = N_c \left(\frac{N_d}{N_c} \right)^{\frac{1}{2}} \exp \left(\frac{E_d - E_c}{2K_B T} \right)$$

$$n = (N_c N_d)^{\frac{1}{2}} \exp \left(\frac{E_d - E_c}{2K_B T} \right) \text{ or } \dots \dots \dots (6)$$

$$n = (N_c N_d)^{\frac{1}{2}} \exp \left(\frac{-\Delta E}{2K_B T} \right) \dots \dots \dots (7)$$

Where $-\Delta E = E_d - E_c$ represents the ionization energy of donors.

P-type semiconductor:

When trivalent impurity such as aluminum, boron, gallium or indium is added to pure silicon, it forms 3 covalent bonds with the neighboring 3 silicon atoms while the fourth bond is not completed due to the deficiency of one electron. Thus the trivalent impurity atom has a tendency to accept one electron from neighboring silicon atom to complete the fourth covalent bond. The energy level corresponding to the electron deficiency that is ‘hole’ is located above the valence band and is called acceptor level.

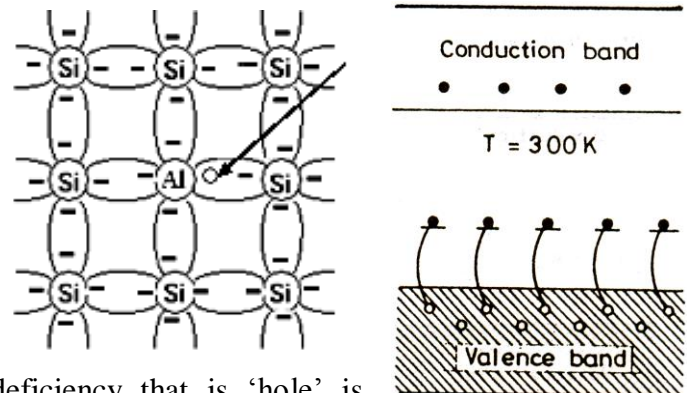

In this type of semiconductor majority charge carriers are holes and minority charge carriers are electrons, called p-type semiconductor.

CONDUCTIVITY OF EXTRINSIC SEMICONDUCTORS:

The expression for conductivity for n-type semiconductors is

$$\sigma_e = ne\mu_e \text{ ----- (1) \quad and}$$

For p-type material is $\sigma_p = ne\mu_h \text{ ----- (2)}$

Where μ_e and μ_h are mobilities of electrons and holes.

Under the condition of thermal equilibrium electron and holes are uniformly distributed in semiconductor and the average velocity of charge carriers is zero, no current flows.

Conductivity is temperature dependent as shown in figure.

At low temp the conductivity increases with increase of temperature.

This is due to increase in the no. of conduction electrons due to ionization of donor impurities.

Conductivity reaches maximum value B in the graph all donors is ionized.

Conductivity decreases further increase with temperature. This is due to decrease of mobility because of scattering of electrons from the periodic potential field.

A sharp rise in conductivity from C to D is due to large increase in intrinsic conductivity.

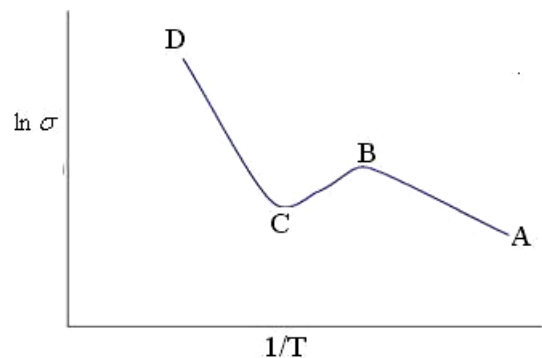

DRIFT & DIFFUSION:

The net current that flows across semi conducting crystal has two components.

- (i) Drift current
- (ii) Diffusion current

Drift Current:

When voltage is applied electrons attracted towards the positive potentials and holes attracted towards the negative potential. This net movement of charge carriers is called drift.

Due to the application of voltage charge carriers attain drift velocity V_d , which is proportional to the electric field E .

$$V_d \propto E$$

$$V_d = \mu E \text{ ----- (1)}$$

Where μ is mobility of charge carriers.

The drift current density J_e due to electrons is defined as the charge flowing across unit area per unit time due to their drift under the influence of field is given by

$$J_{e(\text{drift})} = ne V_d \quad \text{or}$$

$$J_{e(\text{drift})} = ne\mu_e E \quad \text{----- (2)}$$

Where μ_e is mobility of electrons.

The drift current density due to holes in the valence band is

$$J_{h(\text{drift})} = p\mu_h E \quad \text{----- (3)}$$

So the total drift current is

$$\begin{aligned} J_{(\text{drift})} &= J_{e(\text{drift})} + J_{h(\text{drift})} \\ &= e(n\mu_e + p\mu_h) E \quad \text{----- (4)} \end{aligned}$$

The above equation is applicable to intrinsic as well as extrinsic semiconductors. Drift current depends upon two variables

- (i) carrier concentration
- (ii) electric field

Diffusion Current:

In addition to the drift motion, the charge carriers in semiconductor move by diffusion of charge carriers from high concentration to low concentration region. Current produced by the diffusion of the charge carriers is called diffusion current.

Suppose when light or temperature is incident on the semiconductor, additional electron and hole pairs generated and they diffuse through out the semiconductor to restore the equilibrium condition.

Let Δn , Δp be the excess charge of electron and holes respectively. According to Fick's law, diffusion current is proportional to rate of flow of excess charge.

$$\therefore \text{rate of flow of excess charge} \propto - \frac{\partial}{\partial x} (\Delta n) \text{ or}$$

$$\text{Rate of flow of excess charge} = -D_e \frac{\partial}{\partial x} (\Delta n)$$

$$\therefore J_{e(\text{diff.})} = (-e) \text{ rate of flow of excess electrons}$$

$$= eD_e \frac{\partial}{\partial x} (\Delta n) \quad \text{----- (1)}$$

Similarly diffusion current density due to holes is

$$J_{h(\text{diff.})} = (e) \text{ rate of change of excess holes}$$

$$= -D_h \frac{\partial}{\partial x} (\Delta p) \quad \text{----- (2)}$$

∴ Total current density in semiconductor due to electrons is

$$\begin{aligned}
 J_e &= J_{e(\text{drift})} + J_{e(\text{diff.})} \\
 &= n e \mu_e E + e D_e \frac{\partial}{\partial x} (\Delta n) \\
 &= (n \mu_e E + D_e \frac{\partial}{\partial x} (\Delta n)) e \text{ ----- (3)}
 \end{aligned}$$

Current density due to holes is

$$\begin{aligned}
 J_h &= J_{h(\text{drift})} + J_{h(\text{diff.})} \\
 &= p e \mu_h E + (-D_h \frac{\partial}{\partial x} (\Delta p)) \\
 J_h &= (p \mu_h E - D_h \frac{\partial}{\partial x} (\Delta p)) e \text{ ----- (4)}
 \end{aligned}$$

EINSTEIN'S RELATION:

Einstein's relation gives the direct relation between diffusion coefficient and mobility of charge carriers.

At equilibrium condition drift current balances and opposite to the diffusion current .

$$\therefore n e \mu_e E = - e D_e \frac{\partial n}{\partial x} \text{ ----- (1)}$$

Einstein compared the movement of charge carriers with the gas molecules in a container. According to Boltzmann's statistics the concentrations of gas molecules can be written as

$$n = C \cdot \exp\left(\frac{-Fx}{K_B T}\right) \text{ where } x \text{ is distance and } F = eE \text{ is force acting on the charge carriers}$$

$$\frac{\partial n}{\partial x} = C \cdot \exp\left(\frac{-eEx}{K_B T}\right) \cdot \left(\frac{-eE}{K_B T}\right)$$

$$\frac{\partial n}{\partial x} = n \cdot \left(\frac{-eE}{K_B T}\right) \text{ ----- (2) Substitute equ.(2) in equ.(1), we get}$$

$$\therefore n e \mu_e E = n e D_e \left(\frac{eE}{K_B T}\right)$$

$$\frac{D_e}{\mu_e} = \frac{K_B T}{e} \text{ ----- (2) for electrons}$$

$$\frac{D_h}{\mu_h} = \frac{K_B T}{e} \text{ ----- (3) for holes}$$

HALL EFFECT:

Def:- When a semiconductor carrying current 'i' is placed in a magnetic field which is perpendicular to the direction of current, an electric field is developed across the material in a direction perpendicular to both the current direction and magnetic field direction. This phenomenon is known as Hall Effect.

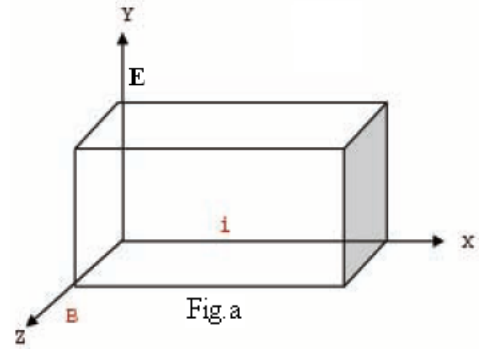

Explanation:

Consider a piece of semiconductor in which current passing along x-axis. When a magnetic field B is applied along z-direction. An electric field is appeared along y-direction.

If the sample is p-type semiconductor holes move with velocity v in x-direction. As they move across the semiconductor these holes experience a transverse force due to magnetic field. This force drives the holes on the lower surface as shown in figure. As a result the lower surface becomes positively charged and upper surface becomes negatively charged and creating Hall field along y-direction.

If the sample is an n-type semiconductor majority charge carriers are electrons, these electrons experience a force 'Bev' in downward direction and lower face gets negatively charged and upper face gets positively charged which is shown in fig.b

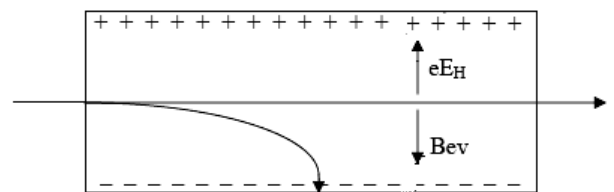

Consider a rectangular slab of n-type semiconductor carrying current in positive x-direction under the magnetic field electrons are deflected to the lower surface because of force 'Bev' due to magnetic field and upper surface gets positively charged because of this electric field a force 'eE_H' acts on electrons in upward direction. The two opposing forces 'Bev' and 'eE_H' establish equilibrium. So

$$Bev = eE_H$$

$$Bv = E_H \text{ ----- (1)}$$

Let 'J' be the current density then

$$J = nev \quad \text{or} \quad v = \frac{J}{ne} \text{ ----- (2)}$$

$$\text{From (1) and (2), } \frac{BJ}{ne} = E_H \text{ ----- (3)}$$

Hall Effect depends on the current density J and magnetic field B.

$$E_H \propto JB$$

$$E_H = R_H JB \text{ ----- (4)}$$

Where R_H is Hall coefficient.

From (3) and (4), $R_H = -\frac{1}{ne} \text{ ----- (5)}$

-ve sign is used because the electric field developed in –ve y-direction.

For p-type semiconductors,

$$R_H = \frac{1}{pe} \text{ ----- (6) where p is hole density.}$$

Determination of Hall coefficient (R_H):

If V_H be the Hall voltage across the sample of thickness ‘t’,

$$E_H = \frac{V_H}{t} \text{ ----- (7)}$$

From (4) and (7),

$$R_H JB = \frac{V_H}{t} \quad \text{or} \quad V_H = R_H JB \times t \text{ ----- (8)}$$

If ‘b’ be the width of the sample then current density $J = \frac{I}{A}$

$$V_H = \frac{R_H I x B x t}{b x t} \quad \text{or}$$

$$R_H = \frac{V_H b x t}{I x B} \text{ ----- (9)}$$

Significance of Hall Effect:

1. By means of Hall Effect we can assess the type of semiconductor whether it is n-type or p-type. Hall coefficient is negative for n-type material.
2. Charge carrier concentration can be evaluated by means of Hall Effect.

$$R_H = \frac{1}{ne} \quad \text{or} \quad n = \frac{1}{eR_H}$$

3. Mobility of charge carriers can be calculated by means of Hall Effect.

$$\sigma = ne\mu \quad \text{and} \quad R_H = \frac{1}{ne}$$

$$\therefore \mu = R_H \sigma$$

4. Hall Effect can be used to determine the power flow in electromagnetic wave

DIRECT AND INDIRECT BANDGAP SEMICONDUCTORS:

According to the band theory of solids, the energy spectrum of electrons consists of large number of allowed energy bands and separated by forbidden regions. The lowest point of the C.B is called conduction band edge and the highest point in V.B is called valence band edge. The gap between them is called band gap or forbidden gap. Based on the band gap semiconductors are classified into two types.

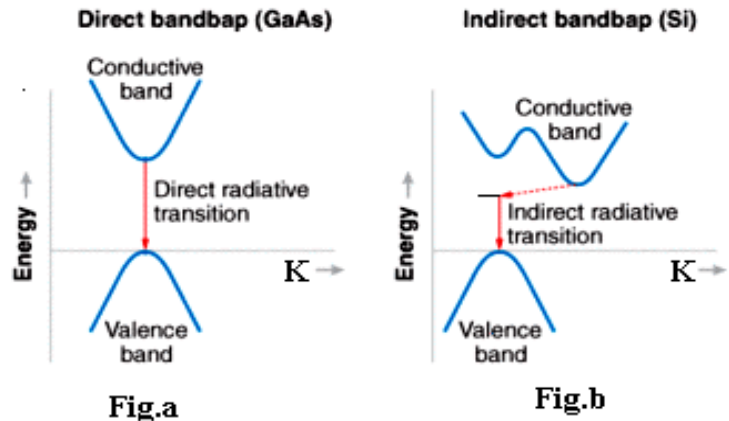

- (i) Direct band gap semiconductors and
- (ii) Indirect band gap semiconductors

Direct band gap semiconductors:

Fig.a shows E-K curve for direct band gap semiconductor. In this case the maximum of the valence band and the minimum of the conduction band occurs at the same value of the 'K'.

In direct band gap semiconductors electrons in the C.B directly recombine with the holes in the V.B.

Energy is released in the form of photons. So LED's and Lasers diodes are prepared with them.

In direct band gap semiconductors life time of charge carries is very less. (i.e excited electrons cannot stay long time in the higher energy states)

Direct band gap semiconductors are formed by compound semiconductors. Ex. InP, GaAs etc.

Indirect band gap semiconductors:

Fig.b shows E-K curve for indirect band gap semiconductor. In this case the maximum of the valence band and the minimum of the conduction band cannot occur at the same value of the 'K'.

In indirect band gap semiconductors electrons in the C.B do not directly recombine with the holes in the V.B. Electrons are trapped in the energy gap called trapping centers.

Energy is released in the form of heat.

In indirect bandgap semiconductors life time of charge carries is longer. So they are used to amplify the signals in diodes and transistors.

Indirect band gap semiconductors are formed by elemental semiconductors. Ex.Si, Ge

EFFECT OF THE TEMPERATURE ON FERMIL LEVEL IN EXTRINSIC SEMICONDUCTOR:

Fig. shows the variation of Fermi level with temp. in N-type semiconductor. In N-type semiconductor, in low temperature region, electrons in conduction band are due to ionization of donor atoms in donor levels. Therefore the Fermi level E_F lies between the donor level E_d and bottom of the conduction band E_c .

$$\therefore E_F = \frac{E_c + E_d}{2}$$

(ionization region) -----
(1)

As the temperature increases, donor atoms gradually ionized and Fermi level shifts downward. At the temperature of depletion (where all donors are ionized) T_d , Fermi level coincides with the donor level E_d .

$\therefore E_F = E_d$ (at $T = T_d$) -----(2)

As the temperature further increase above T_d , the Fermi level shifts downward approximately in linear fashion though the electrons in conduction band remains constant. At the temperature T_i where N-type semiconductor acts as intrinsic, the Fermi level approaches the intrinsic value $E_F = E_g/2$ (intrinsic range)

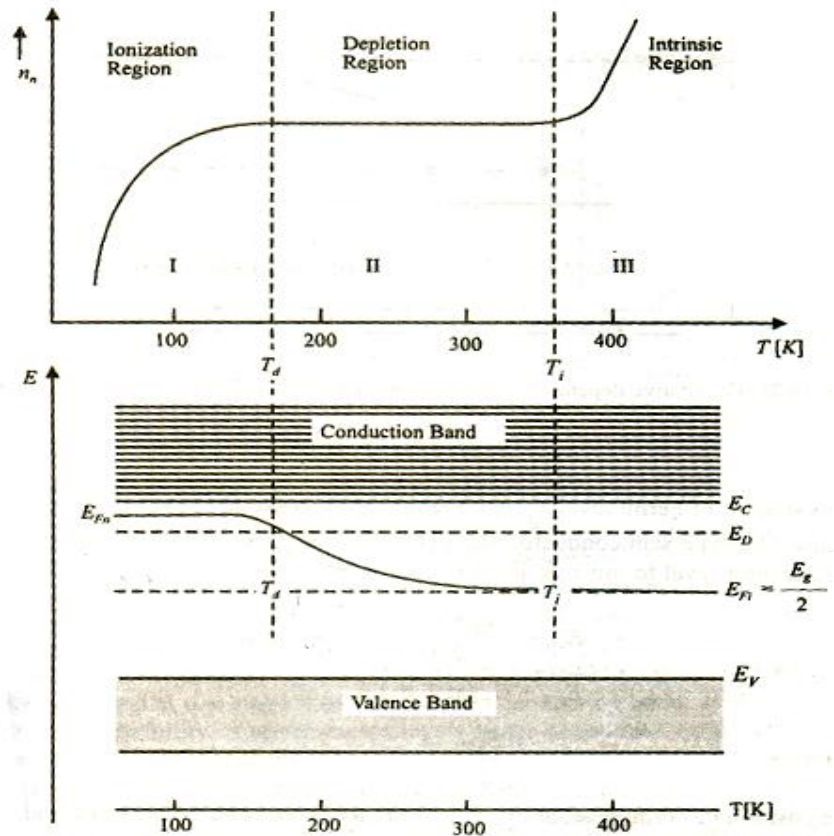

EFFECT OF DOPANT ON FERMIL LEVEL IN EXTRINSIC SEMICONDUCTOR:

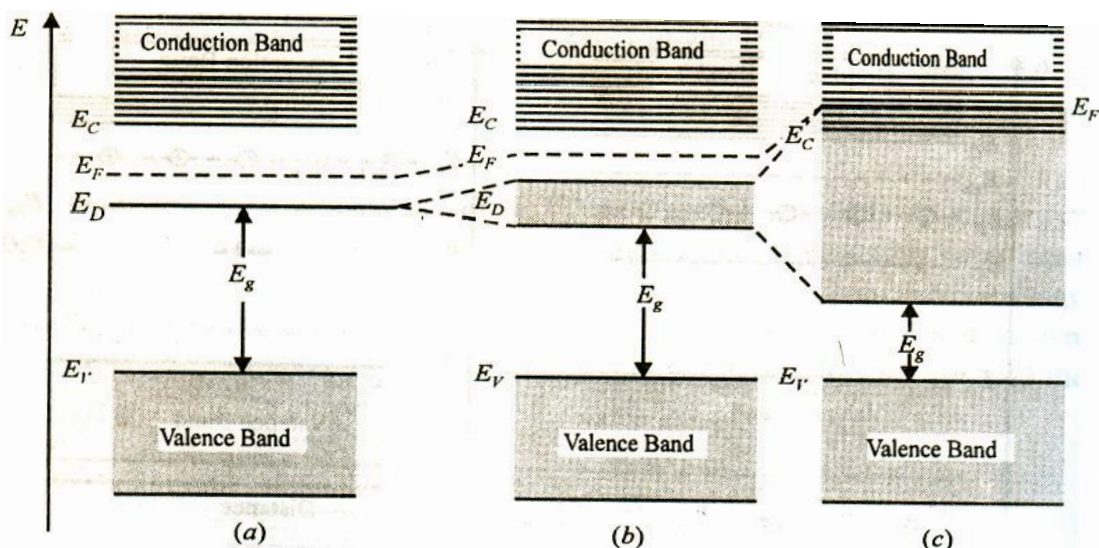

When donor impurities are added to the pure semiconductor, they create extra energy levels below the bottom of conduction band.

When the impurity concentration is low, atoms are far from each other and do not interact with each other. With an increase in the impurity concentration, the interatomic distance between the atoms decrease and atoms interact with each other. Consequently, the donor levels undergo splitting and form an energy band below the conduction band are shown in the fig.(b)

At larger doping concentration the donor band is more broader, and it overlaps on the conduction band as shown in fig.(c)

The broadening of donor level leads to decrease in the width of forbidden gap and upward displacement of the Fermi level, finally E_F moves into conduction band.